

# H4W8PR2

## Network WDR 8MP IR Rugged Mini Dome Camera











OPERATIONAL	
VIDEO STANDARD	NTSC/PAL
SCANNING SYSTEM	Progressive scan
IMAGE SENSOR	1/2" 8Megapixel Progressive Scan CMOS
NUMBER OF PIXELS (H x V)	3840(H) x 2160(V)
MINIMUM ILLUMINATION	0.09lux/F1.9(color,30IRE), 0 Lux with IR ON
S/N RATIO	More than 45dB
ELECTRONIC SHUTTER SPEED	1/3~1/100000s
IR DISTANCE	Up to 30m (98ft), depending on scene reflectance
IR LIGHT CONTROL	Manual/SmartIR/OFF
IR LIGHT NUMBER	2
DAY/NIGHT	Auto (ICR) / Color / B&W
BACKLIGHT COMPENSATION	BLC / HLC / WDR
WHITE BALANCE	Auto/Natural/Street Lamp/Outdoor/Manual/Customized Region
GAIN CONTROL	0~100
WIDE DYNAMIC RANGE	120 dB
NOISE REDUCTION	3D DNR
PRIVACY MASKING	Off / On (4 Areas, Rectangle)
MOTION DETECTION	Off / On (4 Zones, Rectangle)
REGION OF INTEREST	Off / On (4 Zones)
LENS	3.7mm~11mm, F1.9, Motorized
ANGLE OF VIEW	H:113°~50°, V:60°~28°
VIDEO	
VIDEO COMPRESSION	H.264/H.264B/H.264H/H.265/Smart Codec/MJPEG (Sub Stream)
RESOLUTION	4K(3840x2160)/6M(3072x2048)/5M(3072*1728)/5M(2592*1944)/4M(2688*1520)/3M(2048x1536)/3M(2304x1296)/1080P(1920x1080)/1.3M(1280x960)/720P(1280x720) Sub Stream:D1(704x480/576)/VGA(640x480)/CIF(352x240/288)
FRAME RATE	Main Stream: 4K (1~25/30fps) Sub Stream: D1(1~25/30fps)
BIT RATE CONTROL	CBR/VBR
BIT RATE	4Kbps~15104Kbps

NETWORK	
ETHERNET	RJ-45 (10/100Base-T)
SUPPORTED WEB BROWSERS	Internet Explorer (11.0+)
SUPPORTED OS	Windows® 7 32-bit/64-bit; Windows® 10 32-bit/64-bit
PROTOCOLS*	HTTP; HTTPS; TCP; ARP; RTSP; RTP; RTCP; UDP; SMTP; DHCP; DNS; PPPoE; IPv4/v6; QoS; UPnP; NTP; Bonjour; IEEE 802.1x; Multicast; ICMP; IGMP; TLS
INTEROPERABILITY	ONVIF Profile S/G/Q
MAXIMUM USERS ACCESS	20 Users
SECURITY	User account and password protection HTTPS, IP Filter, Digest authentication, User access log, TLS1.2 only, AES-128/256, SSH/Telnet closed, sFTP by default, PCIDSS compliance
EVENT	No SD card, SD card error, Capacity warning, Network disconnection, IP conflict, Illegal access
MICRO SD	Up to 128 GB microSDHC card, Class 10 (not included)
ELECTRICAL	
POWER SUPPLY	DC12V PoE (802.3af) (Class 0)
POWER CONSUMPTION	<10.9W
MECHANICAL	
DIMENSIONS	Ø122mmx88.9mm (4.80"x3.50")
PRODUCT WEIGHT	Approx. 0.49Kg (1.09lb)
PACKAGE WEIGHT	Approx. 0.66Kg(1.46lb)
MATERIAL	Metal
CONSTRUCTION COLOR	RAL9003 (White)
ENVIRONMENTAL	
OPERATING TEMPERATURE	-22°F to 140°F (-30°C to 60°C)
RELATIVE HUMIDITY	Less than 95%, non-condensing
INGRESS PROTECTION	IP66
IMPACT RESISTANCE	IK10
REGULATORY	
EMISSIONS	FCC Part 15B, EN 55032
IMMUNITY	EN 50130-4
SAFETY	UL 60950-1, EN 62368-1
ROHS	EN 50581

\* Some development may be required in specific user cases to support some of these protocols in the field as they mature over time.

# Network WDR 8MP IR Rugged Mini Dome Camera

## RECOMMENDED ACCESSORIES

SYSTEM COMPATIBILITY		MOUNTS AND ACCESSORIES	
HEN*4	8/16/32/64-channel Performance Series 4K NVRs (H.264 and H.265)	HQA-PM2**	 Pole Mount Adapter
HEN*3	4/8/16/32-channel Performance Series 4K NVRs (H.264 and H.265)	HQA-IC	 In-Ceiling Bracket
MOUNTS AND ACCESSORIES		HQA-BB4**	 Junction Box
HQA-RS	 Rain Shield Bracket	HQA-CB**	 Ceiling Mount Bracket for Pendant Mount Cap
HQA-PK**	 Pendant Mount Cap	HQA-CBE**	 Ceiling Mount Extend Bracket for HQA-CB
HQA-WK	 Wall Mount Bracket		

\*\* The HQA-BB4 must be used when installing the camera to HQA-PM2, vice versa.

The HQA-PK must be used when installing the camera to HQA-CB.

The HQA-CBE must be used with HQA-CB together.

## DIMENSIONS

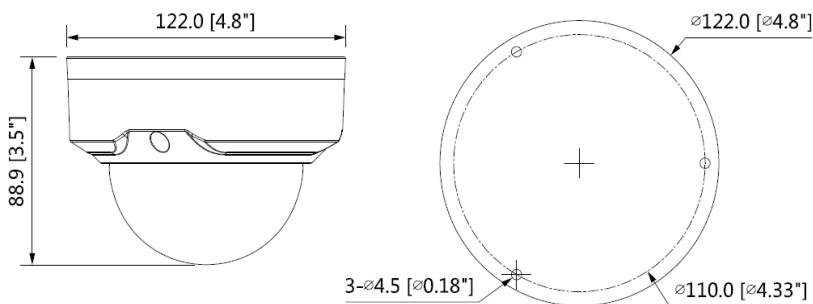

## ORDERING

<b>H4W8PR2</b>	Network WDR 8MP IR Rugged Mini Dome Camera, 1/2.8" CMOS, 3.7mm~11mm Motorized, 2 IR LEDs, PoE, IP66, H.265/H.264/ Smart Codec
----------------	---

### For more information

[www.honeywell.com/security](http://www.honeywell.com/security)

### Honeywell Commercial Security

Aston Fields Road  
Whitehouse Industrial Estate  
Runcorn, Cheshire  
WA7 3DL  
Tel: +44 (0)8448 000 235

### Honeywell Security Office

Emaar Business Park, Sheikh Zayed Road  
Building No. 2, 2nd floor, 201  
Post Office Box 232362  
Dubai, United Arab Emirates  
Tel: +971 44541704  
[www.honeywell.com](http://www.honeywell.com)

ONVIF and the ONVIF logo are trademarks of ONVIF Inc. Honeywell reserves the right, without notification, to make changes in product design or specifications.

HSV-H4W8PR2-01-UK(O119)DS-E  
© 2019 Honeywell International Inc.

**Honeywell**